

8

7

6

5

4

3

2

1

D

D

C

C



B

B

A

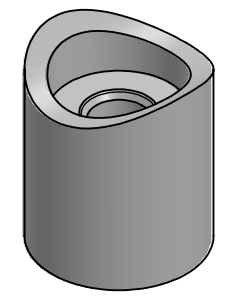
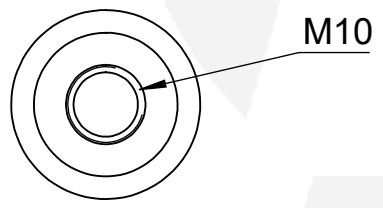
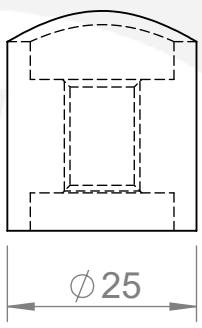
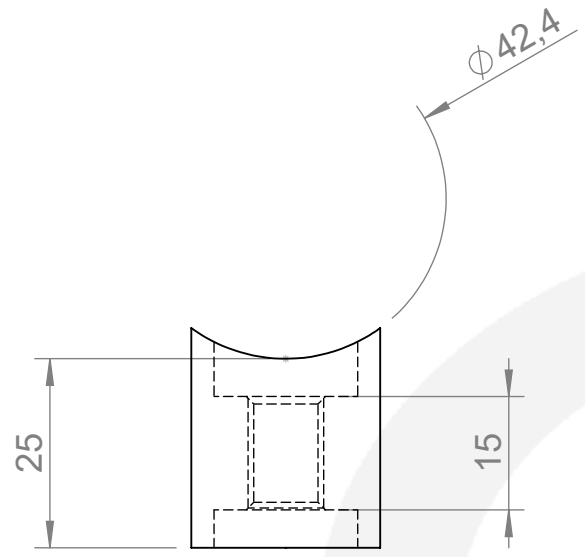
A



| | | | | |
|---|-------------------|-------------------|---|--|
|  | Werkstoff: | | Oberfläche: geschliffen / satinato | |
| | 1.4301 / AISI 304 | | | |
| | Gewicht [kg]: | | Artikel: | |
| | 0.071 | | IN107-311 | |
| | Stk / pz: | | | |
| Datum | | Name | | |
| Gez. 12.08.2021 | | Steve | | |
| Gepr. 12.08.2021 | | Günther | | |
| Norm | | | | |
|   | | Zeichnungsnummer: | | |
| Hauptstr. / Via principale 15 39035 Welsberg/Monguelfo Tel: 0474/947000 Fax: 0474/947001 www.inoxdesign.eu | | Kunde: | | |
| Maßstab: 1:1 | | Format A4 | | |
| | | IN107-311 | | |

8

7

6

5

4

3

2

1