

8

7

6

5

4

3

2

1

D

D

C

C



B

B

A

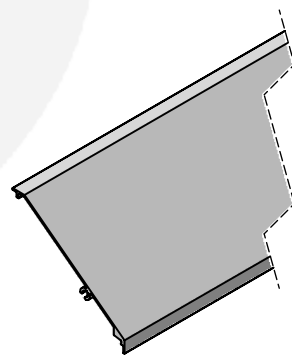
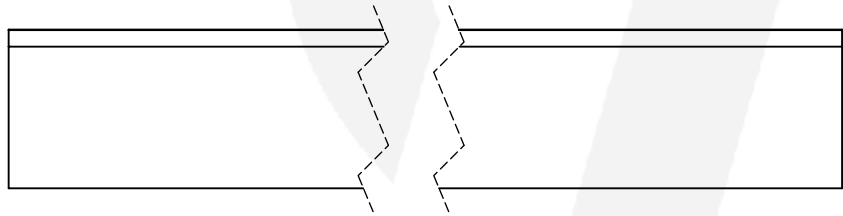
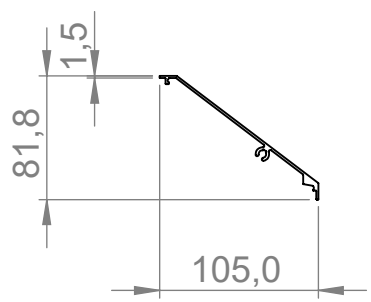
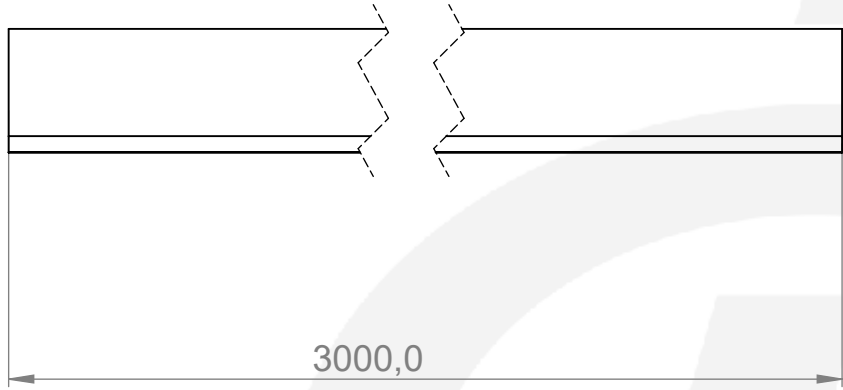
A



	Werkstoff: Aluminium		Oberfläche: Edlestahleffekt	
	Gewicht [kg]: 2.37		Artikel: IN112-316	Stk / pz:
	Datum	Name	Benennung:	
	Gez. 22.11.2021	Steve		
	Gepr. 22.11.2021	Günther	Zeichnungsnummer: IN112-316	
Norm		Kunde:		
Hauptstr. / Via principale 15 I-39035 Welsberg/Monguelfo Tel: 0474/947000 Fax: 0474/947001 www.inoxdesign.eu		 	Maßstab: 1:5	Format A4

8

7

6

5

4

3

2

1