

8

7

6

5

4

3

2

1

D

D

C

C

B

B

A

A

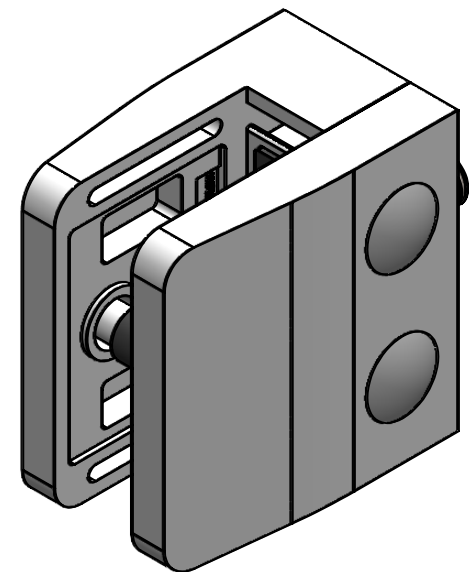
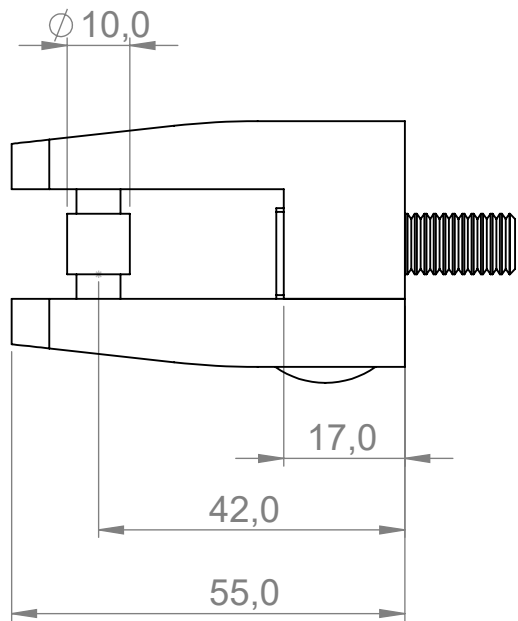
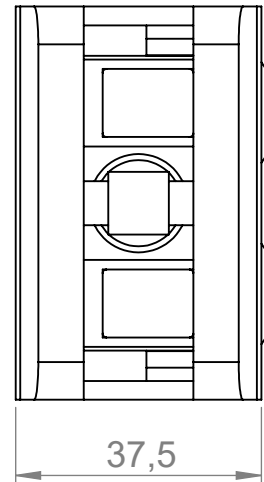
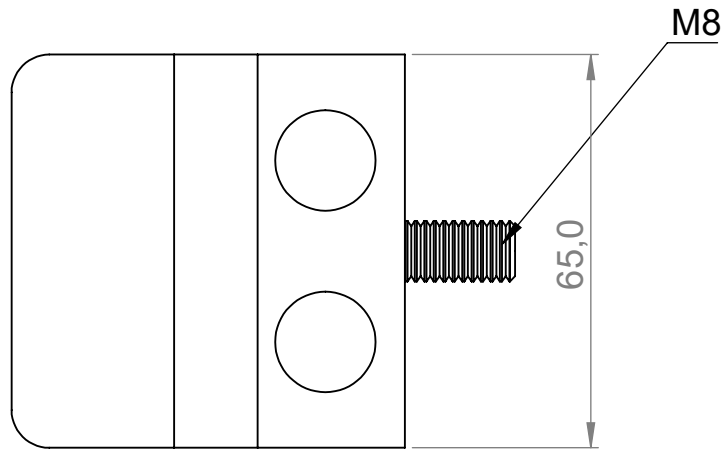

	Werkstoff: 1.4301 / AISI 304		Oberfläche: geschliffen / satinato	
	Gewicht [kg]: 0.33		Artikel: M042-000	Stk / pz:
	Datum	Name	Benennung:	
	Gez. 16.12.2021	Steve	Zeichnungsnummer: M042-000	
Gepr. 16.12.2021	Günther	Kunde:		
Norm		Maßstab: 1:1		Format A4
<small>Hauptstr. / Via principale 15 39035 Welsberg/Monguelfo Tel: 0474/947000 Fax: 0474/947001 www.inoxdesign.eu</small>				

8

7

6

5

4

3

2

1