

8 7 6 5 4 3 2 1

D

D

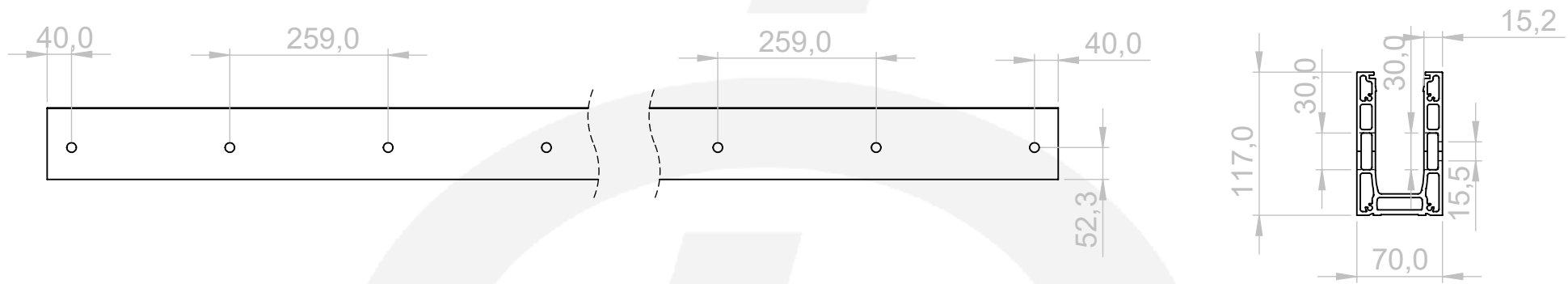

C

C

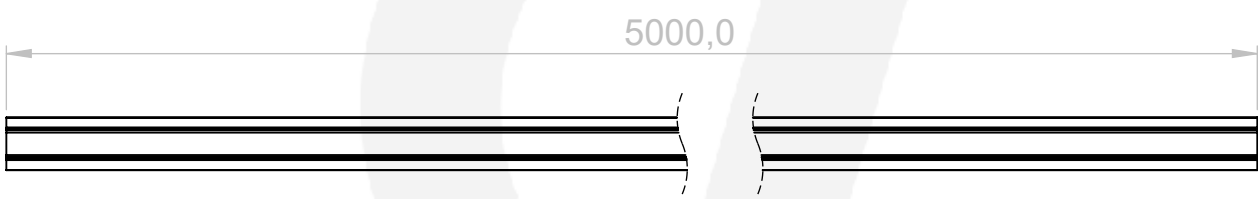





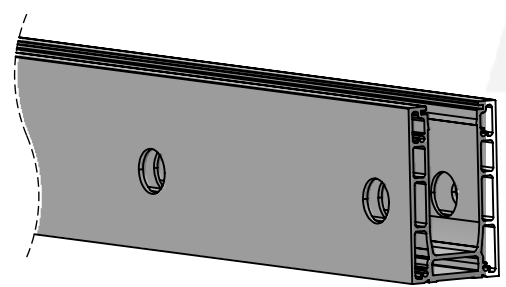

B

B



A

A

	Werkstoff:		Oberfläche: <b>Edelstahleffekt / effetto Inox / stainless steel effect</b>							
	Aluminium		Artikel:							
	Gewicht [kg]: <b>27.00</b>		IN600-611							
	<table border="1"> <tr> <td>Datum</td> <td>Name</td> </tr> <tr> <td>Gez. 21.11.2022</td> <td>Stefan</td> </tr> <tr> <td>Gepr. 21.11.2022</td> <td>Günther</td> </tr> </table>		Datum	Name	Gez. 21.11.2022	Stefan	Gepr. 21.11.2022	Günther	Benennung:	
	Datum	Name								
Gez. 21.11.2022	Stefan									
Gepr. 21.11.2022	Günther									
Norm		Zeichnungsnummer:								
Hauptstr. / Via principale 15 I-39035 Welsberg/Monguelfo Tel: 0474/947000 Fax: 0474/947001 www.inoxdesign.eu		Kunde:								
<table border="1"> <tr> <td>  </td> <td>  </td> </tr> </table>				Maßstab: <b>1:10</b> Format <b>A4</b>						
										
		<b>IN600-611</b>								

8 7 6 5 4 3 2 1